

Anonymity Systems Requirements and Architecture

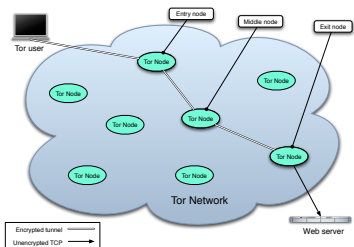

Steven J. Murdoch

<http://www.cl.cam.ac.uk/users/sjm217/>

Anonymous communications

- Anonymous communication systems allow people to communicate without giving away their identity (in practice, IP address)
- Sometimes used in their own right: e.g. for browsing the Internet
- Sometimes used with other privacy enhancing technologies: e.g. Private Information Retrieval, Anonymous credentials
- One growing use is censorship resistance

Construction of the Internet

- Internet Service Providers (ISPs) give people access to the Internet, and allow people to host services such as websites
- ISPs connect to other ISPs so the customers of one ISP can communicate with those of others
- Some ISPs have international connections, others use those of the bigger ISPs
- ISPs are typically based in one country and governed by the laws of that country
- Often governments control international Internet connections, either directly or via regulation

Construction of the Internet

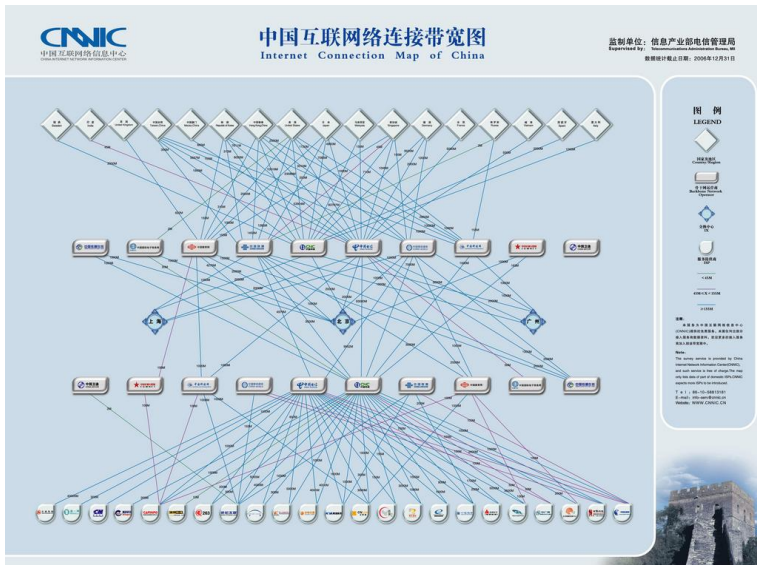
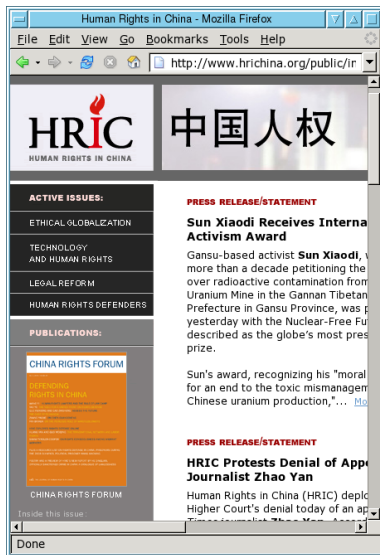

Diagram: China Internet Network Information Center

What is being blocked, and why

- Out of the 40 countries studied by the OpenNet Initiative in 2006, 26 censored the Internet in some way
- The types of material censored varied depending on country, e.g.:
 - Human Rights (blocked in China)
 - Religion (blocked in Saudi Arabia, UAE, Iran, Bahrain)
 - Pornography (blocked in Saudi Arabia, UAE, Iran, Bahrain, Singapore, Burma, ...)
- Other issues censored include: military and militant websites; sex education, alcohol/drugs, music; gay and lesbian websites; news



What is being blocked, and why

- Out of the 40 countries studied by the OpenNet Initiative in 2006, 26 censored the Internet in some way
- The types of material censored varied depending on country, e.g.:
 - Human Rights (blocked in China)
 - Religion (blocked in Saudi Arabia, UAE, Iran, Bahrain)
 - Pornography (blocked in Saudi Arabia, UAE, Iran, Bahrain, Singapore, Burma, ...)
- Other issues censored include: military and militant websites; sex education, alcohol/drugs, music; gay and lesbian websites; news

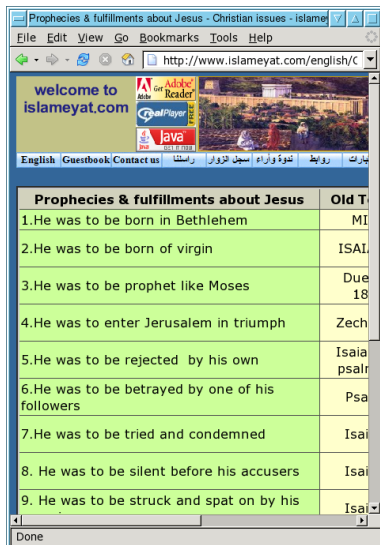

The screenshot shows a web browser window with the address bar displaying 'http://www.islameyat.com/english/C'. The page content includes a header with 'welcome to islameyat.com', navigation links like 'English Guestbook Contact us', and a table with the following data:

Prophecies & fulfillments about Jesus	Old T
1.He was to be born in Bethlehem	MI
2.He was to be born of virgin	ISAI
3.He was to be prophet like Moses	Due 18
4.He was to enter Jerusalem in triumph	Zech
5.He was to be rejected by his own	Isaia psalr
6.He was to be betrayed by one of his followers	Psa
7.He was to be tried and condemned	Isai
8. He was to be silent before his accusers	Isai
9. He was to be struck and spat on by his	Isai

What is being blocked, and why

- Out of the 40 countries studied by the OpenNet Initiative in 2006, 26 censored the Internet in some way
- The types of material censored varied depending on country, e.g.:
 - Human Rights (blocked in China)
 - Religion (blocked in Saudi Arabia, UAE, Iran, Bahrain)
 - Pornography (blocked in Saudi Arabia, UAE, Iran, Bahrain, Singapore, Burma, ...)
- Other issues censored include: military and militant websites; sex education, alcohol/drugs, music; gay and lesbian websites; news



Blocking with technology

- When a country's government controls international connectivity, they can block requests for banned websites
- There are a number of different approaches (DNS blocking, IP address blocking, etc.)
- Software may be produced in-country, but often is an adapted commercial product
- These companies not only make the software, but provide a continuously updated list of websites to be blocked

Normal web browsing

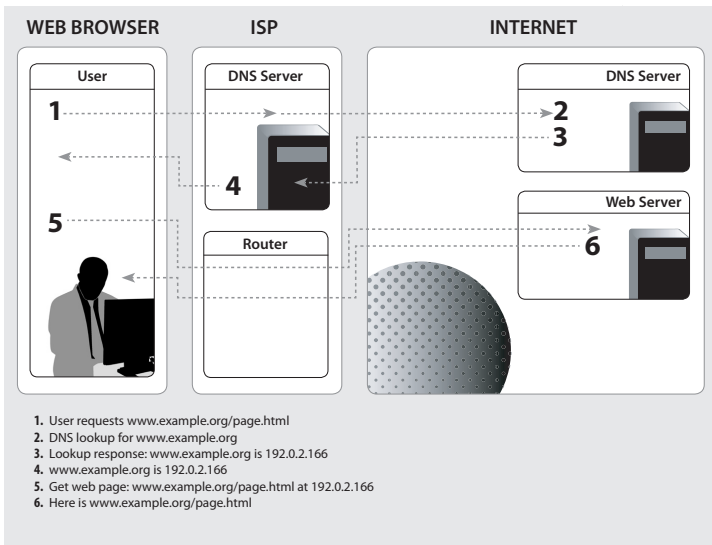

DNS tampering

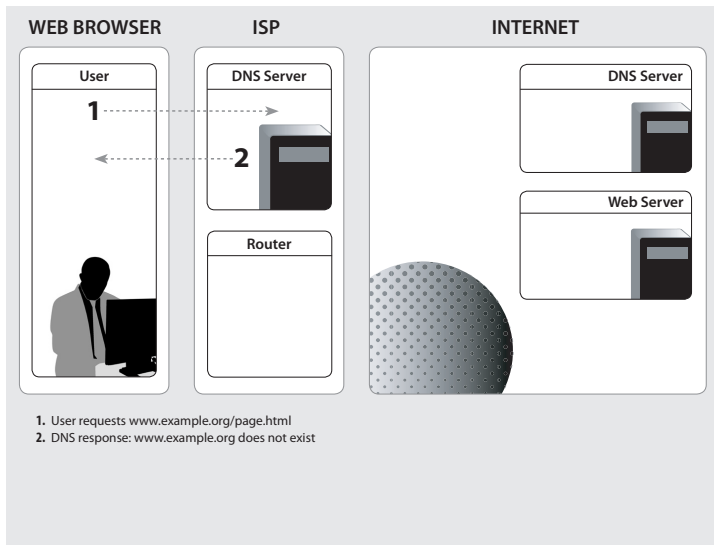

IP blocking

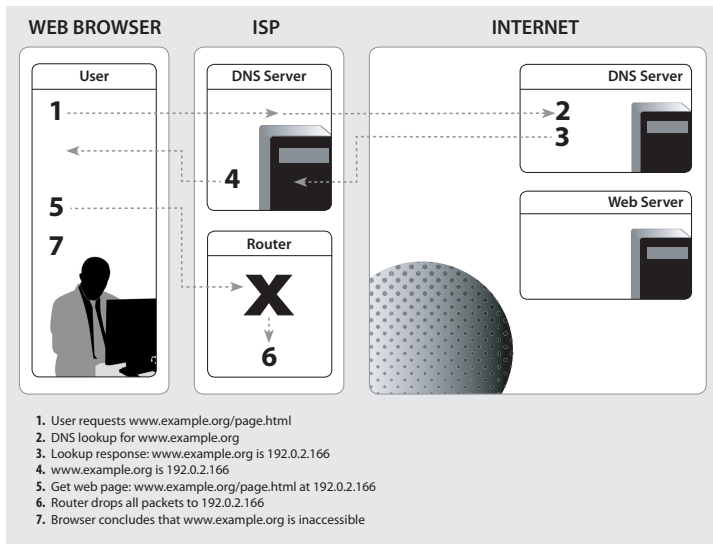

Tradeoffs in blocking systems

- DNS blocking
 - Easy and cheap to implement
 - Blocks at domain name granularity – overblocks protocols, webpages
 - Trivial to bypass
- IP blocking
 - Easy and cheap to implement
 - Blocks at IP address (perhaps port) – overblocks virtual hosting
- Proxy blocking
 - Expensive to implement
 - Blocks at webpage level – low overblocking
- Hybrid blocking – IP based redirection to proxy
 - Tricky to get right, but cheap
 - Has some vulnerabilities
 - Blocks at webpage level – low overblocking

Even if a site is accessible, it may be removed from search engine results

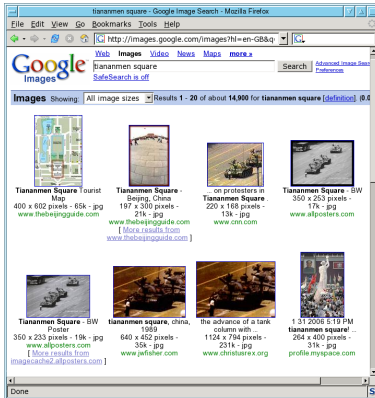

Searching for "Tiananmen Square" on Google.com and Google.cn

Limitations of blocking

- Censorship systems block legitimate content and fail to block banned content
- It is fairly easy for readers and publishers to circumvent the technical measures
- Building and maintaining censorship systems is expensive
- Blocking one type of content encourages other types to be blocked
- Often the process of censorship is not transparent



Photograph: David Gaya

Blocking through laws, fear, and intimidation

- ISPs may be forced to block sites themselves, or implement self-regulation
- People can be intimidated into not testing rules through fear of detection and retribution
- These may be through laws, social pressure or extra-legal punishment
- All these approaches may be used at the same time, and complement each other



Censorship resistance system requirements

- Software to resist censorship should
 - Hide where user is visiting (to prevent blocking)
 - Hide who the user is (to protect them from intimidation)
- These properties should be maintained even if the censorship resistance system is partially compromised

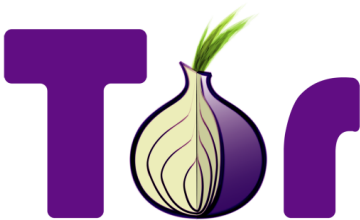

There are many other reasons why people might want privacy

- Ordinary people
 - To avoid personal information being sold to marketers
 - Protect themselves when researching sensitive topics
- Militaries and law enforcement
 - To carry out intelligence gathering
 - Protect undercover field agents
 - Offer anonymous tip lines
- Journalists
 - To protect sources, such as whistle blowers
- Human rights workers
 - To publicise abuses and protect themselves from surveillance
 - Blogging about controversial subjects
- Businesses
 - To observe their competition and build anonymous collaborations

Anonymous communication

- People have to hide in a crowd of other people (“anonymity loves company”)
- The goal of the system is to make all users look as similar as possible, to give a bigger crowd
- Hide who is communicating with whom
- Layered encryption and random delays hide correlation between input traffic and output traffic

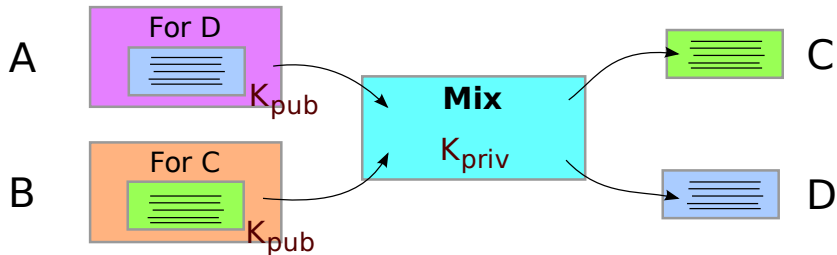

Remailers

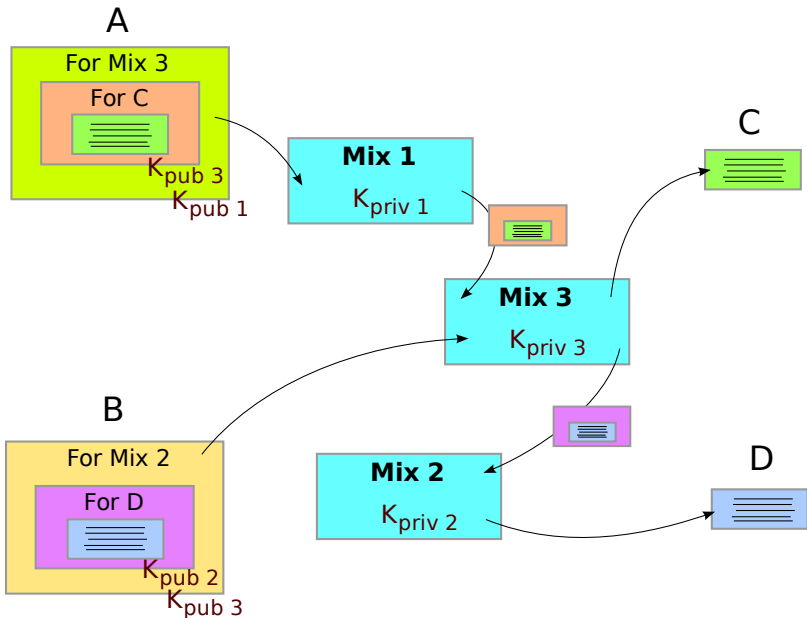

Threshold mix

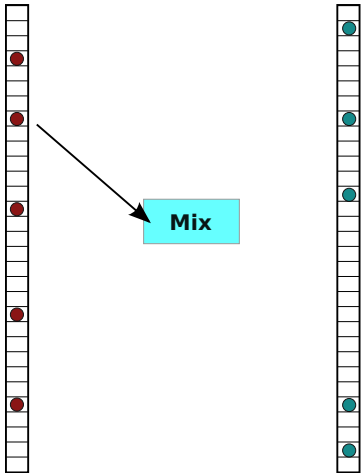

- In each round, the “threshold mix” accepts a fixed number of messages
- Once the number of messages reaches the “batch size” the mix flushes and sends them all, in a random order
- Other strategies are possible, but this is the type of mix we will examine in the exercise
- After observing one round, the attacker knows the set of senders and receivers, but not who sent each message

Threshold mix

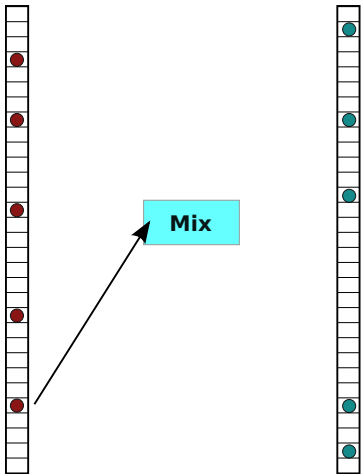

- In each round, the “threshold mix” accepts a fixed number of messages
- Once the number of messages reaches the “batch size” the mix flushes and sends them all, in a random order
- Other strategies are possible, but this is the type of mix we will examine in the exercise
- After observing one round, the attacker knows the set of senders and receivers, but not who sent each message

Threshold mix

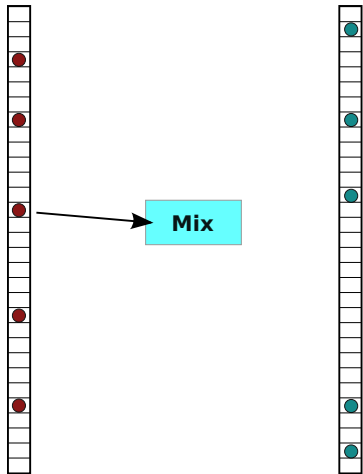

- In each round, the “threshold mix” accepts a fixed number of messages
- Once the number of messages reaches the “batch size” the mix flushes and sends them all, in a random order
- Other strategies are possible, but this is the type of mix we will examine in the exercise
- After observing one round, the attacker knows the set of senders and receivers, but not who sent each message

Threshold mix

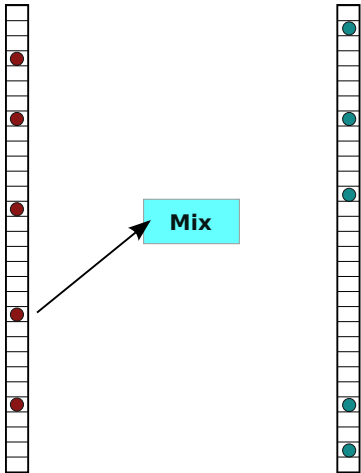

- In each round, the “threshold mix” accepts a fixed number of messages
- Once the number of messages reaches the “batch size” the mix flushes and sends them all, in a random order
- Other strategies are possible, but this is the type of mix we will examine in the exercise
- After observing one round, the attacker knows the set of senders and receivers, but not who sent each message

Threshold mix

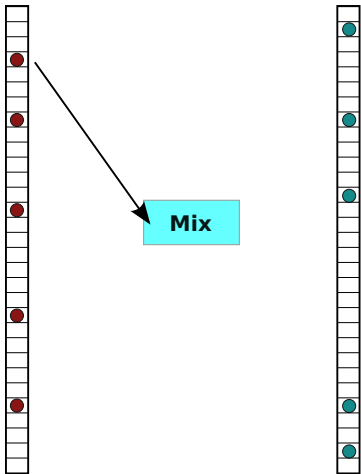

- In each round, the “threshold mix” accepts a fixed number of messages
- Once the number of messages reaches the “batch size” the mix flushes and sends them all, in a random order
- Other strategies are possible, but this is the type of mix we will examine in the exercise
- After observing one round, the attacker knows the set of senders and receivers, but not who sent each message

Threshold mix

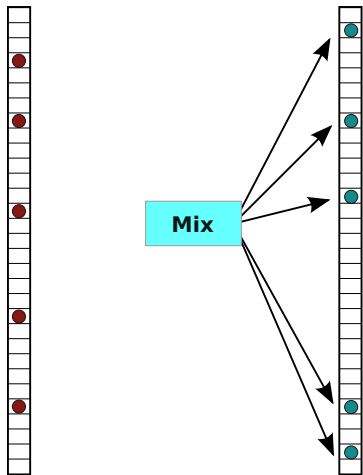

- In each round, the “threshold mix” accepts a fixed number of messages
- Once the number of messages reaches the “batch size” the mix flushes and sends them all, in a random order
- Other strategies are possible, but this is the type of mix we will examine in the exercise
- After observing one round, the attacker knows the set of senders and receivers, but not who sent each message

Traffic Analysis

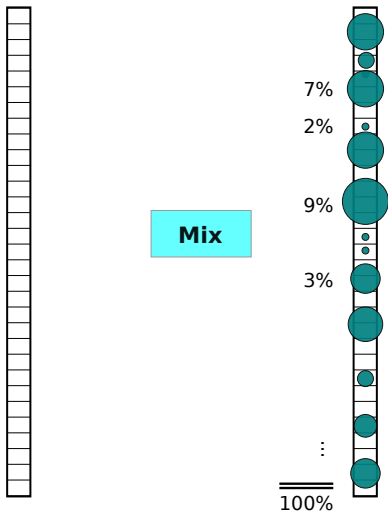

- By observing traffic over many rounds, the adversary can count each recipient's share of the messages received
- Some users will receive more messages than others
- These users may be of interest, so the target of further investigation
- e.g. Bob's share is:
$$\frac{\text{messages received by Bob}}{\text{messages received in total}}$$
over all rounds

Tracking Alice's Contacts

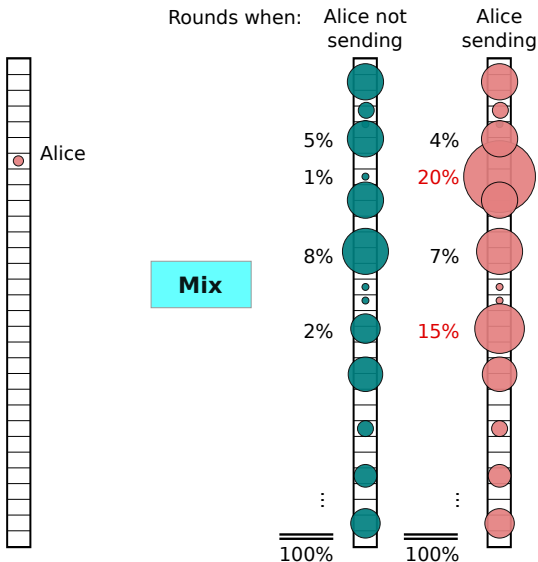

- Can observe each Bob's share in both rounds where Alice was sending, and rounds where she was not
- Recipients whose share jumps when Alice is sending are likely Alice's friends
- Score = (Bob's share in rounds where Alice is sending) – (Bob's share in rounds where Alice **not** sending)

Anonymity systems exist for hiding both email and web traffic

- Hiding web traffic is a fundamentally more difficult problem than hiding email
- Anonymity is achieved by making all traffic look the same (padding) and hiding timing correlations (delays)
- Web traffic is very variable (few kB to few GB): so padding doesn't work well
- Long latencies would be intolerable for interactive traffic: so adding delays don't work well
- However it is not all bad: anonymity needs other users to hide in
- There is much more web traffic than there is email, so this partially makes up for the lower security

Tor is a low-latency anonymity system

- Based on technology developed in the Onion Routing project
- Commonly used for web browsing (works for any TCP traffic)
- Originally built as a pure anonymity system (hides who is talking to whom)
- Now designed to resist censorship too (hides whether someone is using the system at all)
- Centralised directory authorities publish a list of all servers

Tor hides communication patterns by relaying data through volunteer servers

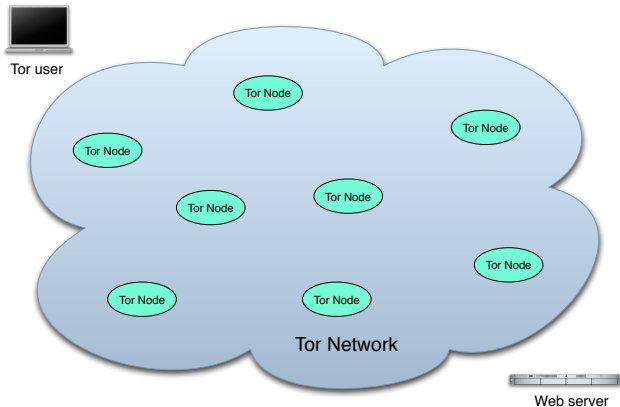

Tor hides communication patterns by relaying data through volunteer servers

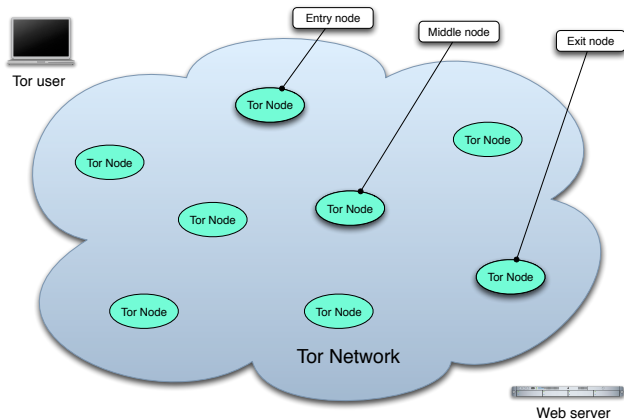

Tor hides communication patterns by relaying data through volunteer servers

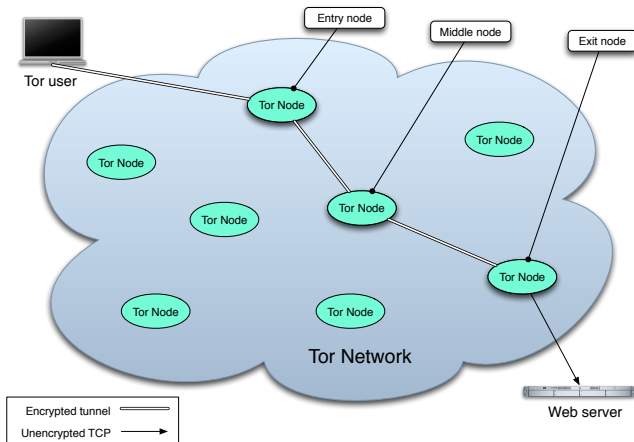

Tor uses two types of encryption

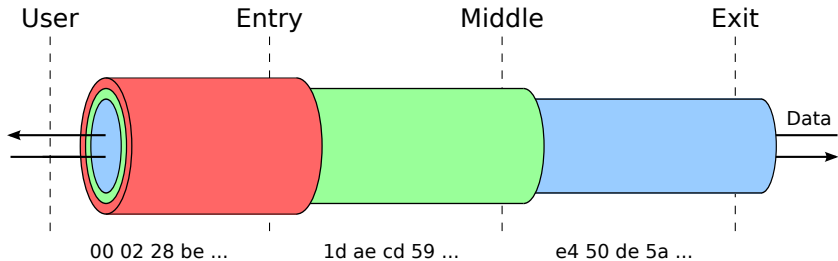

Circuit encryption unlinks data entering and leaving a server

Tor uses two types of encryption

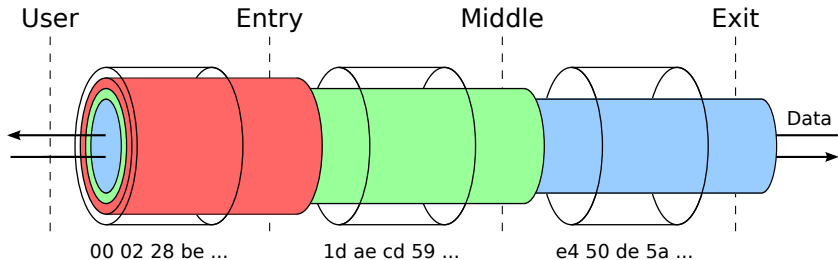

Circuit encryption unlinks data entering and leaving a server
Link encryption (TLS) disguises individual circuits

Tor uses two types of encryption

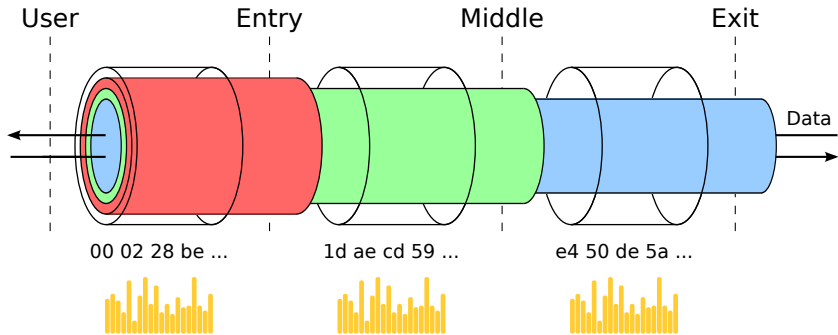

Circuit encryption unlinks data entering and leaving a server
Link encryption (TLS) disguises individual circuits
But data rate is unchanged so traffic analysis can correlate flows

Architectural options: traffic analysis resistance

Resisting traffic analysis comes with a cost

- It requires either long delays, lots of padding, dropping messages, or some combination of these
- Even performing these steps is not sufficient against an adversary who can infiltrate the network
- Delays are used for email anonymous communication systems (e.g. MixMinion and MixMaster)
- Padding and dropping are not used in any widely deployed system
- Tor gains resistance by being well used and widely distributed

Architectural options: topology

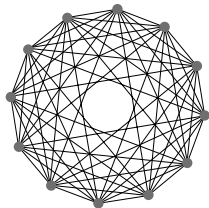

Free Route

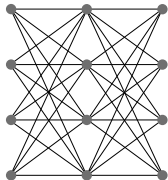

Stratified

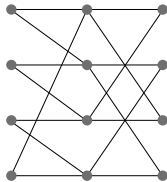

Stratified Restricted

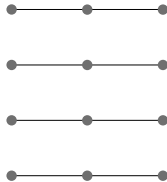

Cascade

Choosing how nodes can connect to other nodes affects:

- Performance
- Security
- Scalability

Architectural options: path selection

Different anonymity systems take different approaches to path selection

- Tor and remailers have a central database and source routing
 - Implementation is easier
 - Central database is a point of vulnerability
- P2P systems let nodes choose next hop on path
 - Reduces resistance to compromised nodes
 - Other attacks become possible

Freenet is an anonymous content distribution network

- While Tor allows access to the Internet, Freenet creates a private network
- Users can create websites, share files and send/receive emails between other members of the network
- Content is hosted by sharing it amongst users of the network
- Users cannot select what content they host, and it is stored in an encrypted form

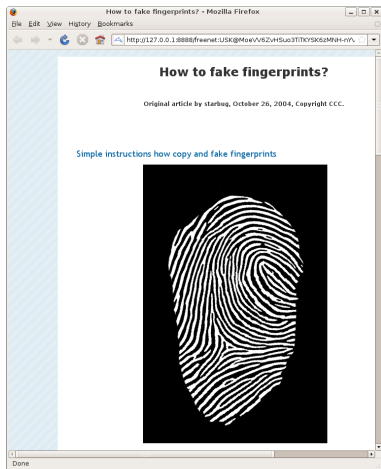

Psiphon a is censorship resistance system with different tradeoffs to Tor

- There is no centralized control, so it is hard to block but also hard for user to find a server
- Users do not have to download software, but this limits the strength of protection
- If the user cannot modify browser settings or install software, Psiphon is still usable
- Users within a censored country can ask someone they trust outside of the country to install the Psiphon server



Further information

“Tools and Technology of Internet Filtering”, a chapter in “Access Denied”.

<http://opennet.net/accessdenied>

“Security Engineering”, 2nd Edition (Chapter 23).

<http://www.cl.cam.ac.uk/~rja14/book.html>

The anonymity bibliography

<http://www.freehaven.net/anonbib/>

The Tor Project website

<https://www.torproject.org/>

A copy of these slides will be available

<http://www.cl.cam.ac.uk/~sjm217/>

